

ПКП 25-ХХ-11



Рис. 11

ПКП 25-ХХ-12

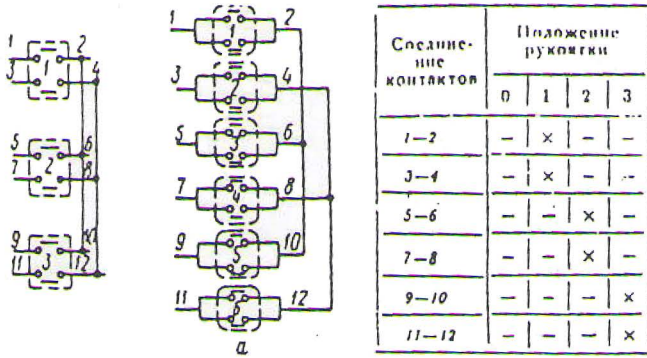

Рис. 12

ПКП 25-ХХ-13

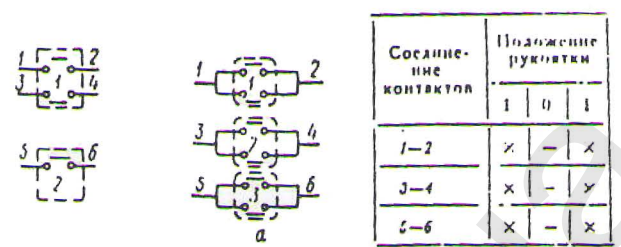

Рис. 13

ПКП 25-ХХ-14

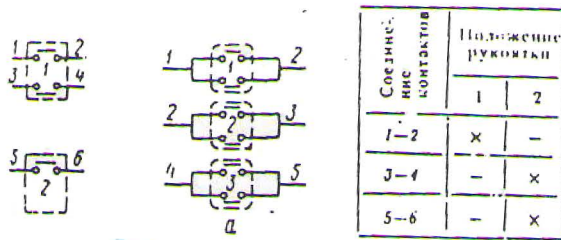

Рис. 14

ПКП 25-ХХ-15

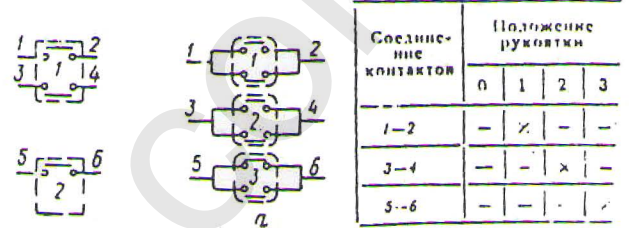

Рис. 15

ПКП 25-ХХ-16

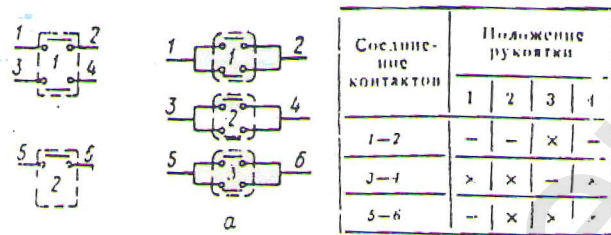

Рис. 16

ПКП 25-ХХ-17

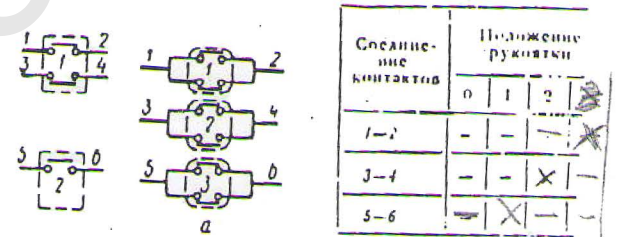

Рис. 17

ПКП 25-ХХ-18

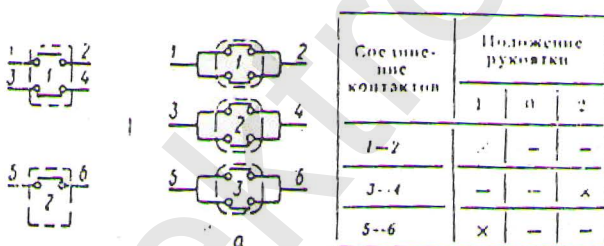

Рис. 18

ПКП 25-ХХ-19



ПКП 25-ХХ-20

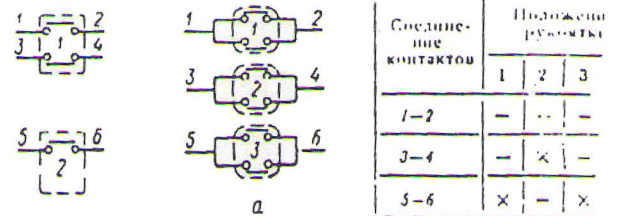
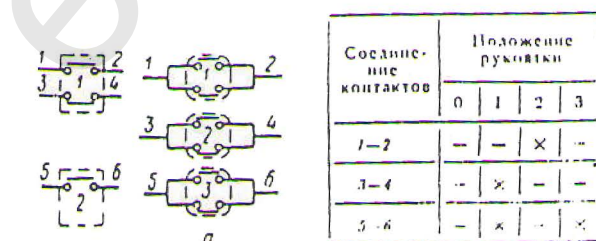